

Q81S



Control panel for 230V ac sliding gates operators

- Automatic programming mode with obstacle detection
- Sequential programming mode: adjustable force, slow down, working time per single motor
- Immediate closing
- Pedestrian opening
- Multi-occupation feature
- Second radio channel interface (optional)
- Output for electrolock connection
- Hammer action and lock pulse function
- Built-in radio receiver 433,92 MHz (32 codes) suitable for fixed or rolling code transmitters
- Input for 8K2 resistive safety edge
- Self diagnosis of malfunctions by LED coding

TECHNICAL FEATURES

Item code	PQ81S
Pcb's dimensions	137 x 84 x 37 mm
Pcb's weight	160 g
Main power supply	230V, 50-60Hz
Power supply tolerance	-10% +20%
Transformer	230/21Vac – 15VA
Main fuse	5 A
Rated power	600 W
Max. power draw	3,5 A
Power draw in stand-by	30 mA
Blinker	24Vac, max 20 W
Accessories	24Vdc , max 5 W
Accessories	-20 +50 °C
Protection rating	IP55

Contents

1.	SAFETY INSTRUCTIONS AND PRELIMINARY CHECKS	<i>pag. 01</i>
2.	DESCRIPTION AND MAIN COMPONENTS	<i>pag. 02</i>
3.	ELECTRICAL CONNECTIONS	<i>pag. 03</i>
3.1	LIMIT SWITCHES WIRING	<i>pag. 05</i>
3.2	MAIN POWER	<i>pag. 06</i>
3.3	START DEVICES	<i>pag. 06</i>
3.3.1	TIMER	
3.3.2	KEY-SWITCH	
3.4	PEDESTRIAN OPENING	<i>pag. 06</i>
3.5	EMERGENCY STOP BUTTON	<i>pag. 07</i>
3.6	PHOTOCELLS	<i>pag. 07</i>
3.6.1	Photocells in CLOSING	
3.6.2	Photocells in OPENING	
3.7	SAFETY EDGE	<i>pag. 08</i>
3.7.1	Safety Edge in CLOSING	
3.7.2	Safety Edge in OPENING	
3.7.3	8K2 resistive safety edge in CLOSING	<i>pag. 11</i>
3.7.4	8K2 resistive safety edge in OPENING	
3.8	FLASHING LIGHT	<i>pag. 10</i>
3.9	HOV TO PLUG THE 2nd RADIO CHANNEL JACK	<i>pag. 10</i>
3.9.1	Auxiliary radio channel AUX	
3.9.2	Signalling light	
3.9.3	CCourtesy light	
4.	DEFAULT SETTINGS	<i>pag. 11</i>
5.	BROWSING THE MENU	
5.1	FUNCTIONS MENU	
5.1.1	Automatic closing	
5.1.2	8K2 RESISTIVE SAFETY EDGE INPUT (cut the power off)	
6.	OPERATION MODE	<i>pag. 12</i>
7.	RADIO CODES	<i>pag. 14</i>
7.1	HOW TO DELETE EXISTING RADIO CODES	
7.2	HOW TO STORE A RADIO CODE FOR START COMMAND	
7.3	HOW TO STORE A RADIO CODE FOR PEDESTRIAN COMMAND	
7.4	HOW TO STORE A RADIO CODE FOR THE 2° AUXILIARY RADIO CHANNEL	
8.	PROGRAMMING	<i>pag. 15</i>
8.1	AUTOMATIC mode	
8.1.1	AUTOMATIC mode with OBSTACLE DETECTION	
8.2	SEQUENTIAL mode	<i>pag. 16</i>
8.2.1	SEQUENTIAL mode with OBSTACLE DETECTION	
9.	TROUBLE SHOOTING	<i>pag. 17</i>

1. SAFETY INSTRUCTIONS AND PRELIMINARY CHECKS

WARNING! Important instructions for the safety of people,  **READ CAREFULLY!**

Save this manual for future consultation.

 Do not allow children to play with the fixed command devices, or in the gate's area of operation.
Keep any remote control devices (i.e. transmitters) away from the children as well

 Children are forbidden to carry out cleaning and maintenance unless accompanied by adults.

 Children over 8 years, persons with reduced physical, sensorial, mental capabilities or unexperienced people are limited to use the operator unless accompanied by a supervisor or unless they get properly aware of potential hazards associated.

 Always cut the power off before operating.

 Make sure the earth connection is duly wired.

Wiring, installation and functional tests must be carried out by expert qualified personnel in full compliance with current regulation EN12453.

Use of this control panel must be restricted to the transformer supplied by the Manufacturer.

A circuit breaker must be fitted close to the gate in compliance with the wiring diagram and installation instructions (see paragraph 3).

Stay clear of the gate's area of operation when in motion

Frequently check the system to see whether any anomalies or signs of wear and tear appear on the moving parts, on the component parts, on the securing points, on the cables and any accessible connections.

If the system requires repairs or modifications, release the operator and do not use it until safety conditions have been restored.

2. DESCRIPTION AND MAIN COMPONENTS

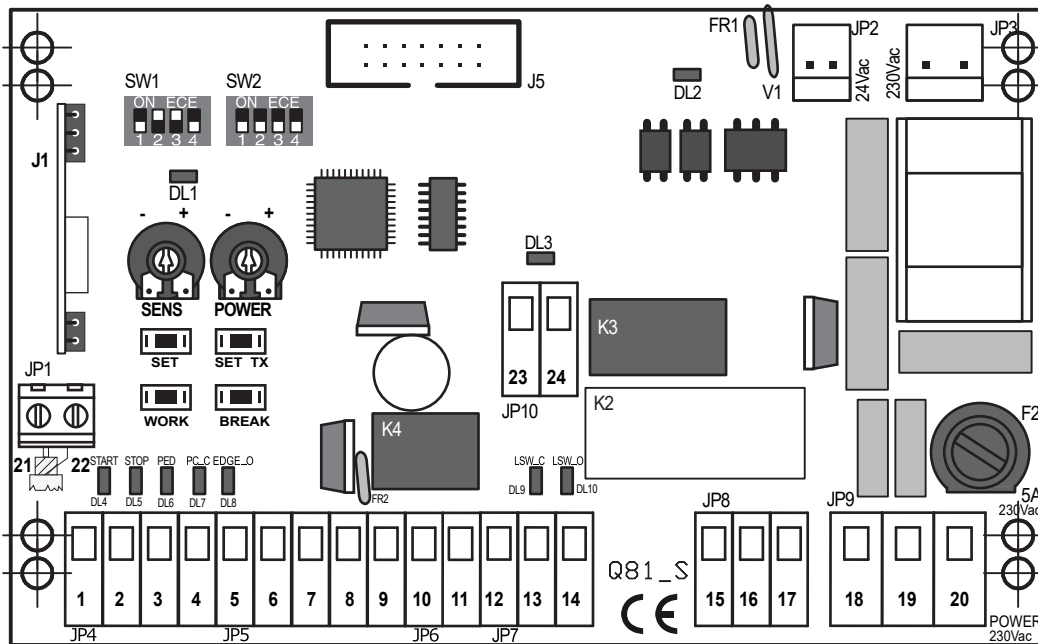

- J1** = radio receiver
J5 = input second radio channel jack
F2 = line fuse 230V 5A
FR1 = self resettable fuse 24V 1,6A
FR2 = self resettable fuse 24V 0,6A
V1 = varistor secondary
K1/K3 = motor relé
K4 = flashing light relé
TR2 = filter

JP1 = GREEN TERMINAL - aerial connection
JP2 = Secondary MOLEX card 24V ac
JP3 = Primary MOLEX card 230V ac
JP4 = BLUE TERMINAL – command devices
JP5 = RED TERMINAL - line and photocells
JP6 = YELLOW TERMINAL – flashing light
JP7 = BLACK TERMINAL - limit switch
JP8 = ORANGE TERMINAL - motor
JP9 = GREEN TERMINAL – line 230V / earth
JP10 = GREEN TERMINAL – safety edge (resistive or mechanical type) only in CLOSING

WARNING LED

- DL1** = PROGRAMMING
DL2 = THRUST MOTOR
DL3 = SAFETY EDGE in CLOSING
DL4 = START
DL5 = STOP
DL6 = PEDESTRIAN START
DL7 = PHOTOCELL IN CLOSING
DL8 = PHOTOCELL IN OPENING
DL9 = LIMIT SWITCH in CLOSING
DL10 = LIMIT SWITCH in OPENING

PROGRAMMING BUTTONS

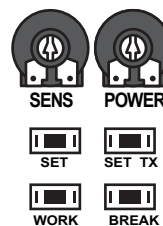

3. ELECTRICAL CONNECTIONS

WIRING Diagram for 230Vac OPERATORS

N.B.:
ALL SAFETY DEVICES MUST BE CONNECTED BEFORE STARTING PROGRAMMING, OTHERWISE THE CONTROL PANEL SHALL

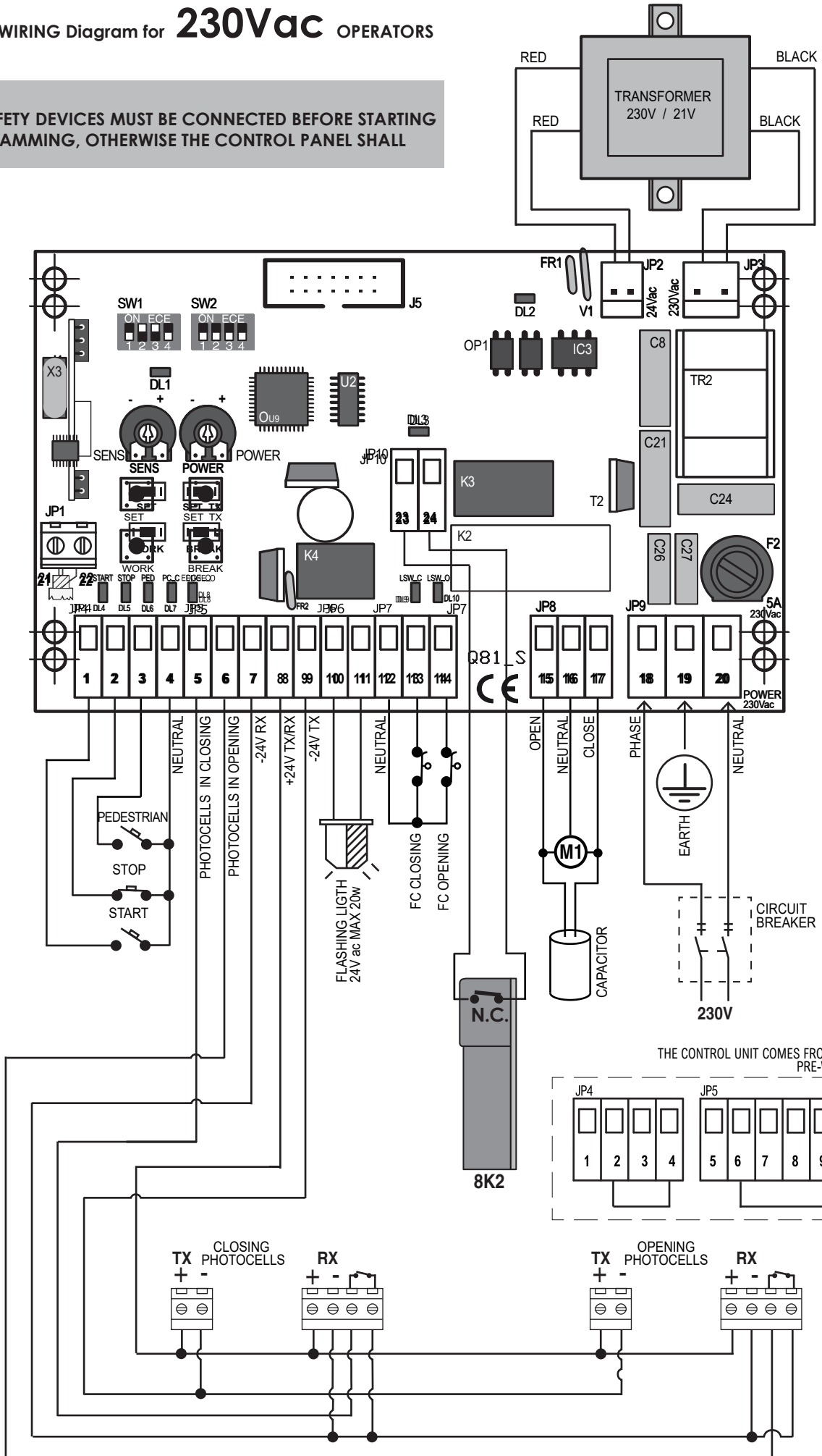

JP1 = GREEN TERMINAL -Aerial connection

- 21 signal wire
- 22 earth wire

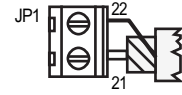

JP2 = RED WIRES - secondary MOLEX card 24V dc



JP3 = BLACK WIRES - primary MOLEX card 230V ac



JP4 = BLUE TERMINAL – command devices

- 1 START (N.O. contact)
- 2 STOP (N.C. contact)
- 3 PEDESTRIAN (N.O. contact)
- 4 NEUTRAL

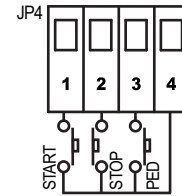

JP5 = RED TERMINAL – line and photocells

- 5 photocell in closing (N.C. contact)
- 6 photocell in opening (N.C. contact)
- 7 RX photocells -24V
- 8 TX/RX +24V
- 9 TX photocells -24V

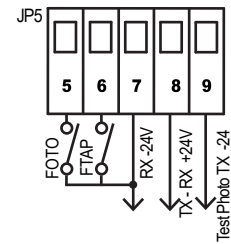

JP6 = YELLOW TERMINAL – flashing light

- 10 flashing light 24V ac - max 20W
- 11 flashing light 24V ac - max 20W

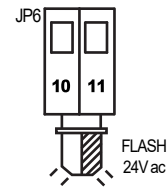

JP7 = BLACK TERMINAL – LIMIT SWITCH

- 12 neutral
- 13 limit switch in closing
- 14 limit switch in opening

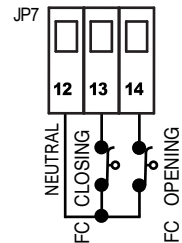

JP8 = ORANGE TERMINAL - MOTOR

- 15 OPEN
 - 16 NEUTRAL
 - 17 CLOSE
- } MOTOR OUTPUT

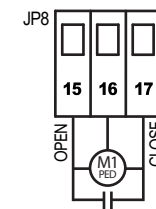

JP9 = GREEN TERMINAL - line 230V + earth

- 18 LINE
- 19 EARTH
- 20 NEUTRAL

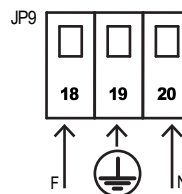

Make sure a circuit breaker is properly fitted to the gate electric box.

JP10 = GREEN TERMINAL – safety edge

- 23 safety edge in CLOSING
- 24 safety edge in CLOSING

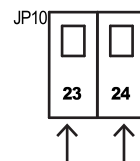

J5 = input second radio channel jack



3.1 MOTORS wiring

Please check motor wirings according to the gate opening direction

Gate opening from left to RIGHT (view from inside courtyard)

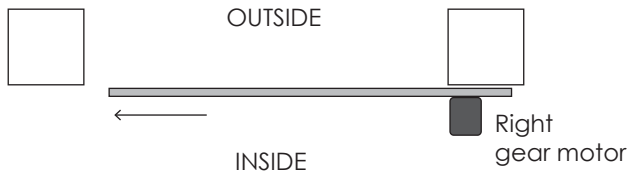

The control unit is pre-set for gate opening from left to right (looking from inside the courtyard as shown in the drawing).

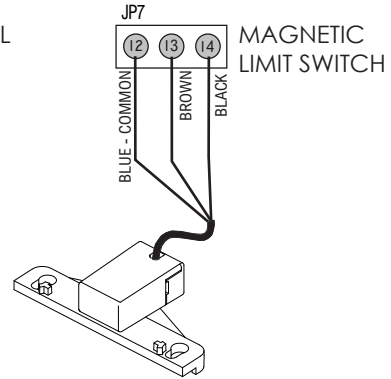
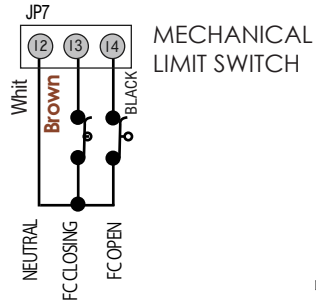
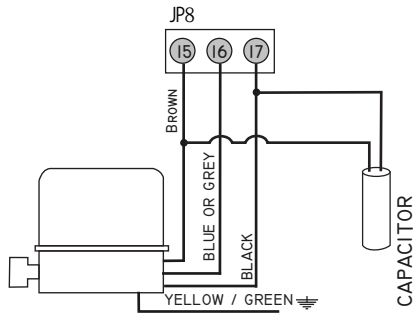

Gate opening from right to LEFT (view from inside property)

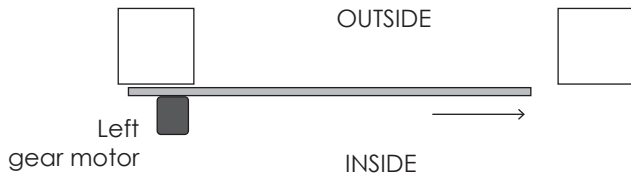

If the motor is positioned on the left, **switch SW2 dip no.1 = ON** (the limit switch turns automatically. No connections are needed)

3.2 MAIN POWER

The main line must be protected by a proper CIRCUIT BREAKER.

Connect the line 230V to **18-19-20**, terminal **JP9**, fulfilling the polarity (18 PHASE – 19 EARTH – 20 NEUTRAL)

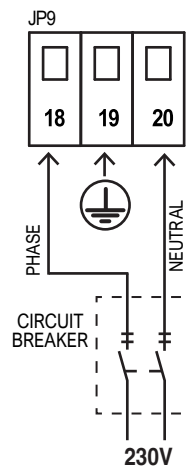

3.3 START DEVICES

Wire the START contact (N.O. contact) to **1 – 4**, terminal **JP4**.

An additional **START** contact can be wired in **PARALLEL** (N.O. contact)

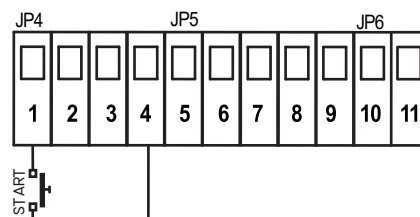

3.3.1 TIMER

It is possible to wire a **TIMER** (N.O. contact) to **1-4**, terminal **JP4**.

ATTENTION!:

when connecting a **TIMER**, the multi-users function must be enabled. SW1 DIP 2 = ON

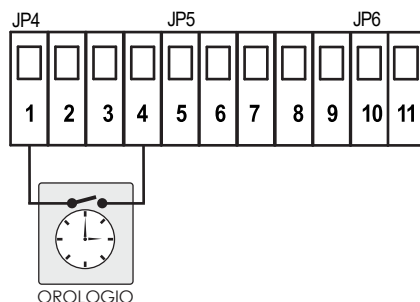

3.3.2 KEY SWITCH

Wire the **KEY SWITCH** (N.O. contact) to **1-4**, terminal **JP4**.

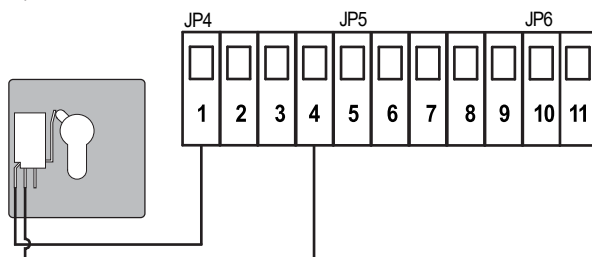

3.4 PEDESTRIAN OPENING

Wire the **PEDESTRIAN START** (N.O. contact) to **3-4**, terminal **JP4**.

An additional **PEDESTRIAN START** contact can be wired in **PARALLEL** (N.O. contact).

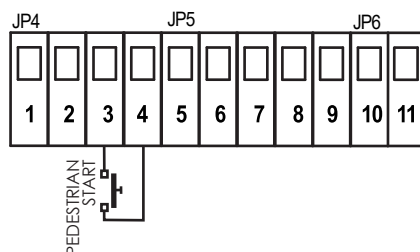

3.5 EMERGENCY STOP BUTTON

Wire the **STOP BUTTON** (N.C. contact) to **2-4**, terminal **JP4**.

An additional STOP BUTTON contact can be wired in **SERIES** (N.C. contact)

 **The EMERGENCY STOP BUTTON is important for the safety of people and objects**

N.B.: Before wiring any STOP contact remove the jumper between **terminal 2** and **terminal 4**.

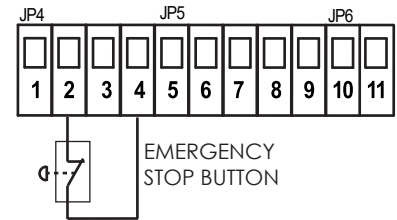

3.6 PHOTOCELLS

3.6.1 Photocells IN CLOSING

Feed the photocells through **7-8-9**, terminal **JP5**.

Wire the photocell contact (N.C. contact) to **5-7**, terminal **JP5**.

An additional photocell set can be wired in **SERIES** (N.C. contact).

- If the photocell beam is broken during **CLOSING**, the gate stops and reverses after 1,5 sec.
- If the photocell beam is broken during **OPENING**, the gate keeps on working normally.

 **The PHOTOCELLS IN CLOSING are important for the safety of people and objects.**

N.B.: To disable the photocell in closing during installation, **plug 5 and 9 together**.

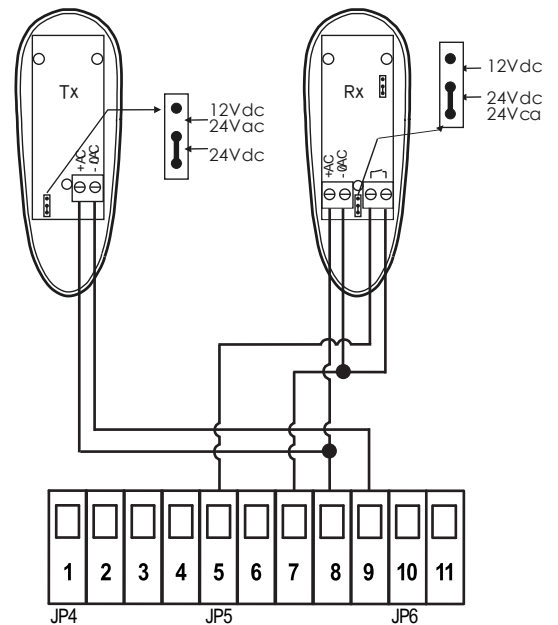
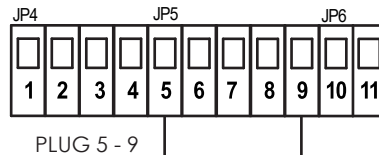

3.6.2 Photocells in OPENING

Feed the photocells through **7-8-9**, terminal **JP5**.

Wire the photocell contact (N.C. contact) to **6-7**, terminal **JP5**.

An additional photocell set can be wired in **SERIES** (N.C. contact).

- If the photocell beam is broken during **OPENING**, the gate stops and reverses for 3 sec

 **The PHOTOCELLS IN OPENING are important for the safety of people and objects..**

N.B.: Before wiring any PHOTOCELL in **OPENING**, remove the jumper between **terminal 6** and **terminal 9**.

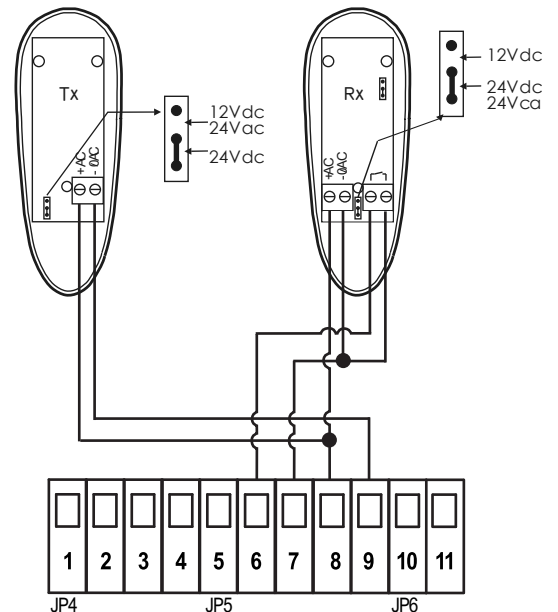

3.7 SAFETY EDGE

3.7.1 Mechanical safety edge in CLOSING

Wire the safety edge to **23 - 24**, terminal **JP10**.

- If the contact is broken during **CLOSING**, the gate stops and reverses.
- If the contact is broken during **OPENING**, the gate keeps on working normally

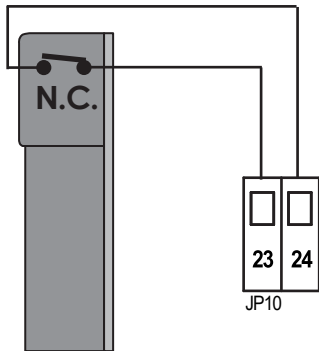

N.B.: Before wiring any SAFETY STRIP in CLOSING, remove the jumper between **terminal 23** and **terminal 24**.

Mechanical safety edge + photocells in CLOSING

Wire the safety edge and the N.C. contact of the photocell in series.

- If the contact is broken during **CLOSING**, the gate stops and reverses.
- If the contact is broken during **OPENING**, the gate keeps on working normally.

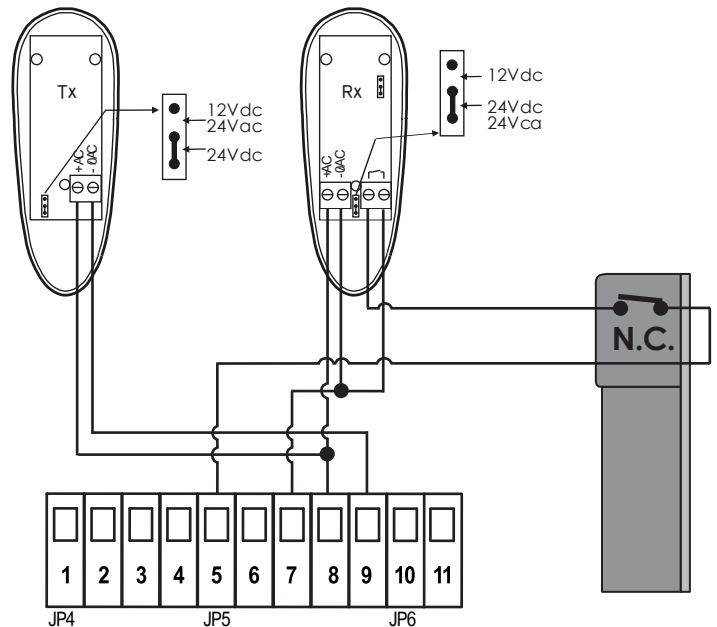

3.7.2 Mechanical safety edge in OPENING

Wire the safety edge to **6 - 9**, terminal **JP5**.

- If the contact is broken during **OPENING**, the gate stops and reverses after 3 sec.
- If the contact is broken during **CLOSING**, the gate keeps on working normally.

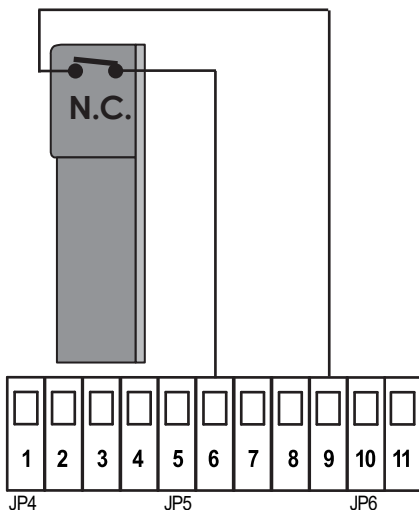

Mechanical safety edge + photocells in OPENING

Wire the safety edge and the N.C. contact of the photocell in series.

- If the contact is broken during **OPENING**, the gate stops and reverses after 3 sec.
- If the contact is broken during **CLOSING**, the gate keeps on working normally.

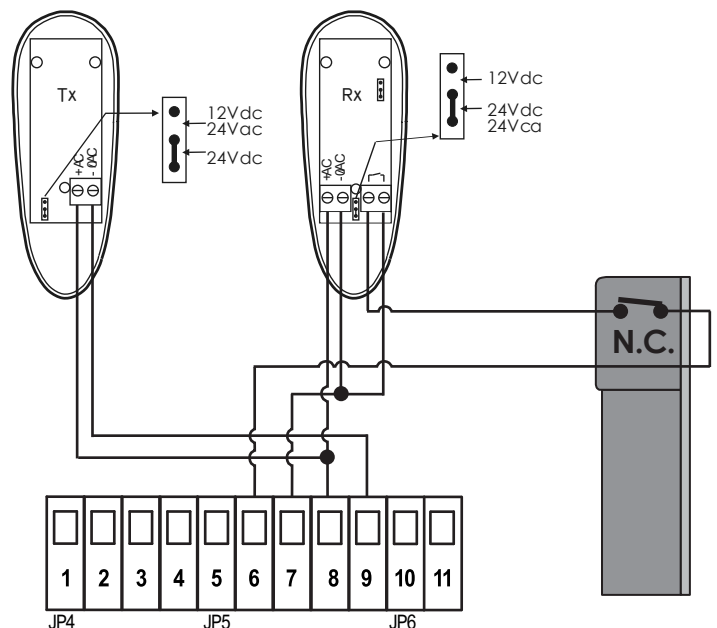

3.7.3 8K2 RESISTIVE SAFETY EDGE IN CLOSING (cut the power off before proceeding)

ATTENTION!:

Wire the **8K2** safety edge to **23 - 24**, terminal **JP10**.
Press **SET + SET TX** together and feed the control panel.

- If the contact is broken during **CLOSING**, the gate stops and reverses.
- If the contact is broken during **OPENING**, the gate keeps on working normally.

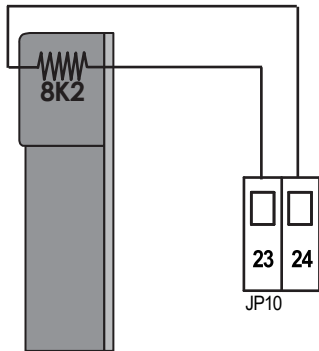

N.B.: Before wiring any SAFETY STRIP in CLOSING, remove the jumper between terminal 23 and terminal 24.

8K2 SAFETY EDGE + PHOTOCELLS IN CLOSING (cut the power off before proceeding)

ATTENTION!:

Wire the **8K2** safety edge to **23 - 24**, terminal **JP10**.
Press **SET + SET TX** together and feed the control panel.

- If the contact is broken during **CLOSING**, the gate stops and reverses.
- If the contact is broken during **OPENING**, the gate keeps on working normally.

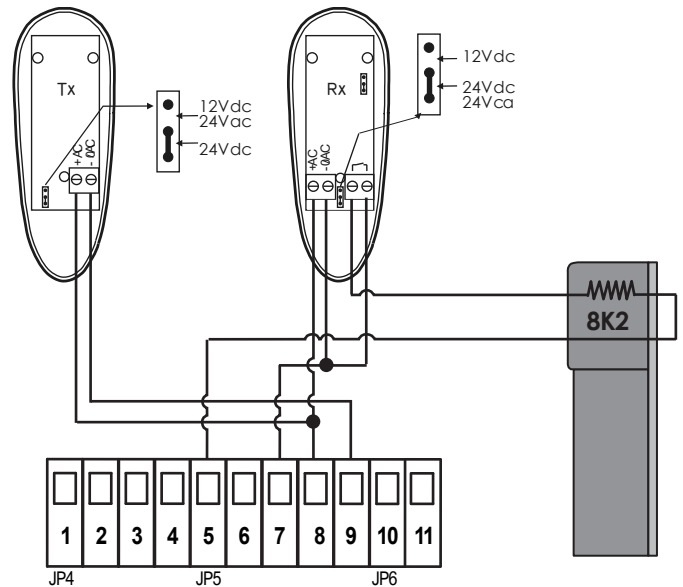

3.7.4 8K2 RESISTIVE SAFETY EDGE IN OPENING (cut the power off before proceeding)

ATTENTION!:

Wire the **8K2** safety edge to **6 - 9**, terminal **JP5**.
Press **SET + SET TX** together and feed the control panel.

- If the contact is broken during **OPENING**, the gate stops and reverses for 3 sec.
- If the contact is broken during **CLOSING**, the gate keeps on working normally

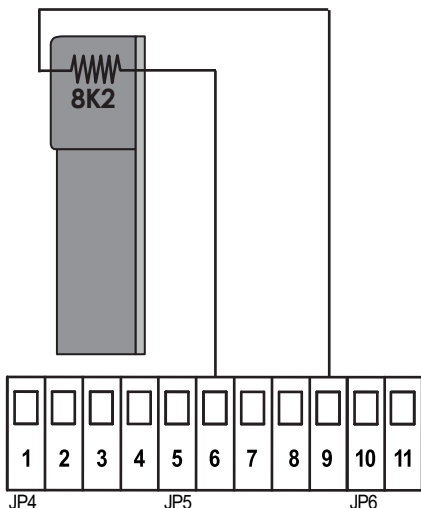

8K2 SAFETY EDGE + PHOTOCELLS IN OPENING (cut the power off before proceeding)

ATTENTION!:

Wire the **8K2** safety edge contact in series to the N.C. contact of the photocell.
Press **SET + SET TX** together and feed the control panel.

- If the contact is broken during **OPENING**, the gate stops and reverses for 3 sec.
- If the contact is broken during **CLOSING**, the gate keeps on working normally.

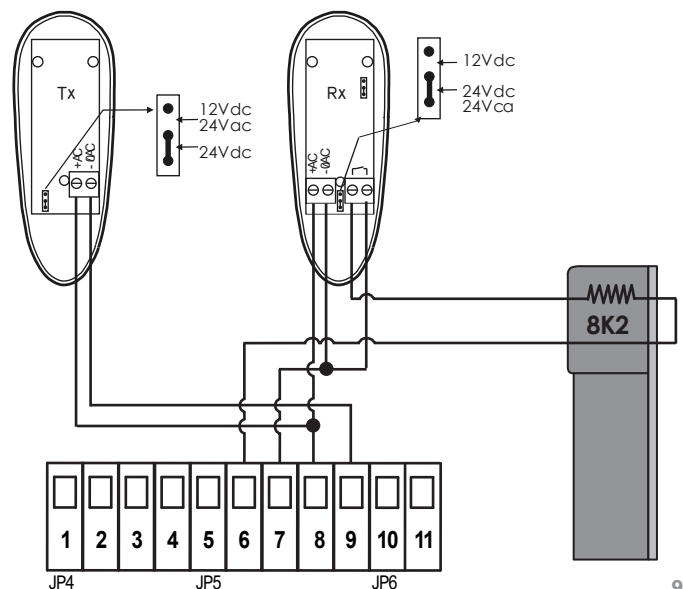

3.8 FLASHING LIGHT

EWire the flashing light (max 20W) to **10-11**, terminal **JP6**.

- **QUICK** blinking → **OPEN**
- **SLOW** blinking → **CLOSE**
- **FIXED** light on → **PAUSE**

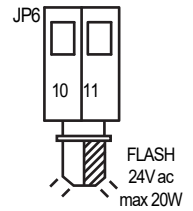

3.9 HOW TO PLUG THE 2nd RADIO CHANNEL JACK



ATTENTION!
CUT THE POWER OFF BEFORE PLUGGING THE INTERFACE

Plug the **MRX01** jack (optional) onto connector **J5**, respecting the slot orientation.

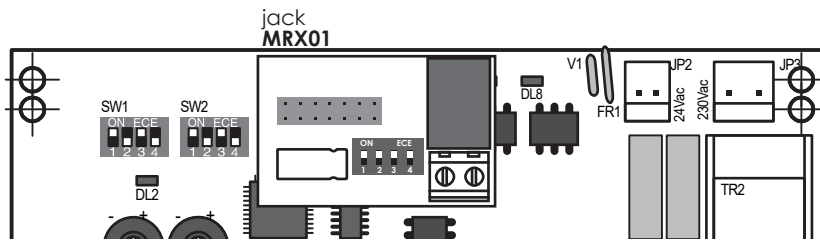
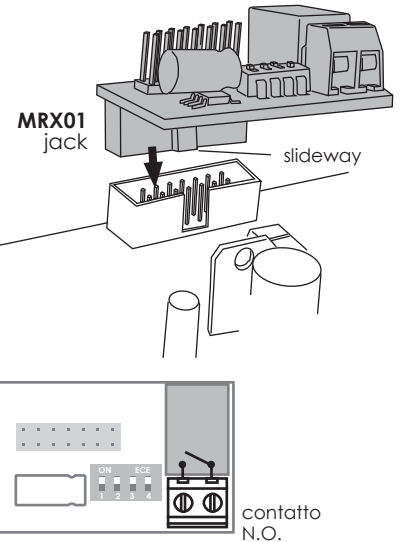

3.9.1 Auxiliary radio channel AUX

To use the **MRX01** interface as second radio channel, proceed this way (see section 7.4):



Before setting the dip-switch SW1, make sure the power is OFF

MONOSTABLE COMMAND

The contact **ACTIVATES** when giving a start command by the remote control. If you wish to choose this function mode, select the switches as follows:
1 = ON 2 = OFF 3 = OFF 4 = NO EFFECT



BISTABLE COMMAND

The contact **ACTIVATES** or **DEACTIVATES** every time you press the remote control. If you wish to choose this function mode, select the switches as follows:
1 = OFF 2 = ON 3 = OFF 4 = NO EFFECT

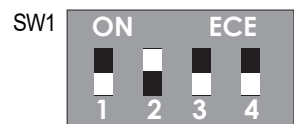

TIMED COMMANDA

The contact **ACTIVATES** when giving a start command by the remote control and **stays for 90 seconds**. If you wish to choose this function mode, select the switches as follows:
1 = ON 2 = ON 3 = OFF 4 = NO EFFECT

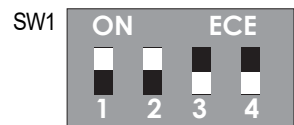

3.9.2 Signalling LIGHT

The contact **ACTIVATES** at **OPENING** and **DEACTIVATES** only at **FINAL CLOSING POSITION**. If you wish to choose this function mode, select the switches as follows:
1 = OFF 2 = OFF 3 = ON 4 = NO EFFECT

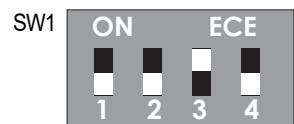

3.9.3 Courtesy LIGHT

The contact **ACTIVATES** at **OPENING** and **DEACTIVATES** after 90 from complete duty cycle. If you wish to choose this function mode, select the switches as follows:
1 = ON 2 = OFF 3 = ON 4 = NO EFFECT



4. DEFAULT SETTINGS

The control panel is supplied with a DEFAULT SETTINGS:
working time, slow down and automatic closing for a standard gate.

To reload the DEFAULT SETTINGS:

- Press **BREAK** to cut the power **OFF** and to turn it **ON**
- Turn **SENS** to the maximum (+) and **POWER** to half position

5. BROWSING THE MENU



SET



SET TX

SET

Use **SET**:

- To program the control panel (section **8.1. AUTOMATIC MODE** – **8.2. SEQUENTIAL MODE**).
- To activate or deactivate the automatic closing (section **5.1.1**)



WORK



BREAK



SET



SET TX

SET TX

Use **SET TX**:

- To store or to delete a radio code.



WORK



BREAK



SET



SET TX

WORK

Use **WORK**:

- As **START** command
- For **SEQUENTIAL PROGRAMMING**



WORK



BREAK



SET



SET TX

BREAK

Use **BREAK**:

- To activate and set the **AUTOMATIC CLOSING TIME** (section **5.1.1**)



WORK



BREAK

5.1 FUNCTIONS MENU

5.1.1 AUTOMATIC CLOSINGA

The **AUTOMATIC CLOSING DEFAULT** is set at 3 sec.

To set the **AUTOMATIC CLOSING TIME**:

- Press **SET** for 3 sec. **DL1** blinks, release **SET**.
- Press **BREAK** and release.
- The blinker and led **DL1** light up, the control panel starts the count down.
- Press **BREAK** again when reached the desired time, the blinker turns off.
The time has been set (automatic closing time max. 120 sec.).

To deactivate the **AUTOMATIC CLOSING**:

- Press **SET** for 3 sec. and release, the led **DL1** blinks.
- Press **BREAK** and hold for 5 sec., the **AUTOMATIC CLOSING** has been deactivated.

5.1.2 8K2 RESISTIVE SAFETY EDGE INPUT (cut the power off)

To activate the **8K2** input as safety in opening and closing press **SET + SET TX** and turn the control panel on.

6. OPERATION MODE

Choose the operation mode you wish selecting the switches SW1 – SW2.
The control panel is supplied with the following default settings.

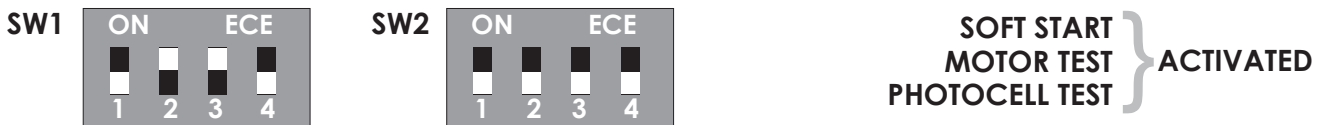

How to read switch positio:

ON WHITE switch **DOWNWARD** = Function OFF
OFF

ON WHITE switch **UPWARD** = Function ON
OFF



ATTENTION: Turn the power off before setting the switches

SWITCH SW1
dip n° 1



ON

OFF = **MULTI OCCUPATION** mode **DEACTIVATED**



ON = **MULTI OCCUPATION** mode **ACTIVATED**

OFF

This function gives priority to the first open command. The control unit won't accept additional START commands during OPENING and AUTOMATIC CLOSING COUNT DOWN.

dip n° 2



ON

OFF = **Soft start mode DEACTIVATED**

At opening motors work at the set thrust (POWERO)

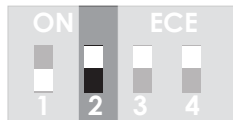

ON = **Soft start mode ACTIVATED**

At opening motors perform at maximum thrust for 1,5 sec., to continue after at the set thrust

OFF

dip n° 3

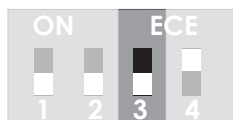

ON

OFF = **Motor and photocell TEST DEACTIVATED**



ON = **Motor and photocell TEST ACTIVATED**

OFF

dip n° 4



ON

OFF = **Immediate closing mode DEACTIVATED**



ON = **Immediate closing mode ACTIVATED**

The gate starts CLOSING after 1,5 sec. bypassing the AUTOMATIC CLOSING COUNT DOWN

OFF

SWITCH SW2

dip n° 1



ON

OFF = = Motor positioned on the RIGHT (Default)



ON = Motor positioned on the LEFT

OFF

dip n° 2



ON

OFF = N.C. contact limit switches(Default)

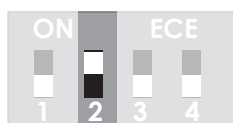

ON = N.O. contact limit switches

OFF

dip n° 3

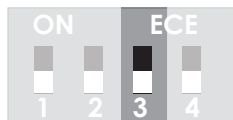

ON

OFF = Standard slow down (Default)



ON = Soft slow down ACTIVATED

OFF

dip n° 4



ON

OFF = Maintained action DEACTIVATED (Default)



ON = Maintained action ACTIVATED

OFF

7. LOADING RADIO CODESO

The control panel DOESN'T ALLOW TO LOAD any remote control if SAFETY DEVICES are DISCONNECTE.

Make sure inputs no. 2 STOP (DL5), no. 5 photocell in CLOSING (DL7), no. 6 photocell in OPENING (DL8) and no. 23 SAFETY EDGE IN CLOSING (DL3), are connected.

LED OFF = input DEACTIVATED

LED ON = input ACTIVATED

If no safety device has been wired, proceed to bridge temporarily the terminal according to chapter 3.6.1.

The control panel has been designed to operate with fixed code or rolling-code remote controls. Choose the remote control you wish to store carefully: once the remote control has been loaded and memorized, the control panel shall only recognize that kind of radio code **without possibility of reset**.

Before starting proceed to delete all existing radio codes.

7.1 DELETING EXISTING RADIO CODES

- Press **SET-TX** and keep pressed for 10 seconds (DL1 blinks).
- **DL1** turns off. **All codes have been deleted.**

7.2 LOADING A REMOTE CONTROL AS START COMMAND

- Press **SET-TX** once: **DL1** blinks (1 blink – stop – 1 blink)
- Load within 5 sec. the remote control you wish to store.
The control panel has stored the radio code and goes out the programming automatically.
It is possible to load until 32 different radio codes (Start + Pedestrian + 2° radio channel).

7.3 LOADING A REMOTE CONTROL AS PEDESTRIAN COMMAND

- Press **SET-TX** twice. **DL1** blinks (2 blinks – stop – 2 blinks)
- Load within 5 sec. the remote control you wish to store.
The control panel has stored the radio code and goes out the programming automatically.

7.4 LOADING A REMOTE CONTROL AS 2° RADIO CHANNEL COMMAND (MRX01 jack)

- Press **SET-TX** three times. **DL1** blinks (3 blinks – stop – 3 blinks)
- Load within 5 sec. the remote control you wish to store.
The control panel has stored the radio code and goes out the programming automatically.

8. PROGRAMMING

The control panel is supplied with a **SEQUENTIAL PROGRAMMING DEFAULT** (obstacle detection excluded)

ATTENTION:

Before starting **PROGRAMMING** make sure mechanical ground stops have been properly fitted.

8.1 AUTOMATIC mode

8.1.1 AUTOMATIC mode with OBSTACLE DETECTION

ATTENTION!:

Before proceeding to programming, start a functional cycle test to proof the motor's thrust.

The thrust has to be proper to the gate weight no matters if light or heavy gates.

If adjustments are needed, regulate **POWER** so that the gate doesn't stop opposing a light contrast pressure.

- Start programming with cool operator.
- The **AUTOMATIC MODE PROGRAMMING** can only perform if mechanical ground endstops are fitted, in Opening and Closing

- Gate in **CLOSING POSITION**.
- **SENS** in half position.
- If during programming the gates stop before reaching the ground endstops, turn **SENS** (sensitivity) clockwise (to +).
- Press **SET** and keep pressed for 10 sec., **DL1** starts blinking.
- When motor starts working release **SET**.
- Motor runs firstly a **FULL OPENING** till reaching the limit switch in opening. Then it starts **CLOSING** till reaching the closing limit switch.
- When the procedure is finished, all time settings are saved. The control panel is now ready for normal operation.

ATTENTION!:

Check the proper **GATE OPERATION SENSITIVITY**.

If adjustments are needed, turn **SENS** clockwise (to +) and regulate accordingly.

The sensitivity has to be proper in order to prevent uncorrect operation.

OBSTACLE DETECTION OPERATION

- If an obstacle is detected in opening, **the gate stops and reverses for 10 cm**.
- The gate starts closing automatically after 30 sec., and this will be for 3 attempts. If the area still remains unclear the gate stays open.
- If an obstacle is detected in closing, **the gate stops and reverses till fully open**.
- The gate **starts closing automatically after 30 sec.**, and this will be for 3 attempts. If the area still remains unclear the gate stays open.

8.2.1 SEQUENTIAL mode WITHOUT Obstacle Detection

ATTENTION!:

Before proceeding to programming, start a functional cycle test to proof the motors' thrust.

The thrust has to be proper to the gate weight no matters if light or heavy gates.

If adjustments are needed, regulate POWER so that the gate doesn't stop opposing a light contrast pressure.

- Start programming with cool operator.
- The AUTOMATIC MODE PROGRAMMING can only perform if mechanical ground endstops are fitted, in Opening and Closing

- **SENS** in maximum position (to +)
- Programming can be carried out both with the remote control or **WORK button**.
- Press **TEST** for 3 sec., **DL1** starts blinking, release.
- Press the button of the remote control previously loaded. The gate **STARTS OPENING**.
- At 80% of opening press the remote control to start **SLOW DOWN** till reaching the opening limit switch.
- Now operational settings are **LOADED**.
- The gate starts closing until reaching the closing limit switch.
- When the procedure is finished, all time settings are saved, the control panel goes out from the sequential programming and is ready for normal operation.

Check the good operation of the gate. If time settings need to be adjusted go back to programming and repeat the whole programming procedure.

9. TROUBLE SHOOTING – ERROR MESSAGES

The control panel is designed to display errors through a LED lighting system.
Here below the trouble shooting table.

Led	Error		
DL9	OFF	<ul style="list-style-type: none"> Closing limit switch ACTIVATED 	Release and open the gate manually, the LED must turn on.
DL1	2 blinks, stop, 2 blinks	<ul style="list-style-type: none"> Photocell test 	Check the wiring and operation of the photocell.
	3 blinks, stop 3 blinks	<ul style="list-style-type: none"> Motor test 	Check the wiring and operation of the motors.
	OFF	<ul style="list-style-type: none"> Power supply disconnected 	Check the connection to the power supply (230V).
DL4	ON	<ul style="list-style-type: none"> Permanent START command 	Check the operation of the ACCESSORIES wired to the START (N.O. contact, see section 3.3).
DL5	OFF	<ul style="list-style-type: none"> STOP button disconnected. 	Check the wiring otherwise deactivate the input.
		<ul style="list-style-type: none"> Incorrect wiring. 	Check the wiring diagram (see section 3.5)
DL7	OFF	<ul style="list-style-type: none"> Photocell in closing non-aligned. 	Check the photocell alignment.
		<ul style="list-style-type: none"> Obstacle detected between the photocell. 	Check and remove the obstacle.
		<ul style="list-style-type: none"> Incorrect electric wiring. 	Check the wiring diagram.
		<ul style="list-style-type: none"> Disconnected photocell. 	Check the power connection.
		<ul style="list-style-type: none"> Disconnected photocell active input. 	Disable the photocell input (see section 3.6)
DL8	OFF	<ul style="list-style-type: none"> Disconnected safety edge. 	Check the connection (N.C.) and the good operation of the safety edge.
		<ul style="list-style-type: none"> Photocell in opening non-aligned. 	Check the photocell alignment.
		<ul style="list-style-type: none"> Obstacle detected between the photocell. 	Check and remove the obstacle.
		<ul style="list-style-type: none"> Incorrect electric wiring. 	Check the wiring diagram.
		<ul style="list-style-type: none"> Disconnected photocell. 	Check the power connection.
DL6	ON	<ul style="list-style-type: none"> Permanent PEDESTRIAN command. 	Check the operation of the ACCESSORIES wired to the PEDESTRIAN START (N.O. contact).
DL10	OFF	<ul style="list-style-type: none"> Opening limit switch ACTIVATED. 	Release and close the gate manually, the LED must turn on.
		<ul style="list-style-type: none"> Incorrect electric wiring. 	Check the wiring diagram and the good operation of the micro switch in opening.
DL3	OFF	<ul style="list-style-type: none"> Bordo sensibile non collegato. 	Check the wiring.
		<ul style="list-style-type: none"> Faulty safety edge. 	Check the safety edge conditions.

CE COMPLIANCE DECLARATION

Manufacturer: **PROTECO S.r.l.**

Address: Via Neive, 77 – 12050 Castagnito (CN) – ITALIA

declares that

The product type: **Q81S** electronic controller for sliding gate automation (1 motor), 230V

Models: **PQ81S**

Accessories: **MRX01**

Is built to be integrated into a machine or to be assembled with other machinery to create a machine under provisions of 2006/42/EC Machinery Directive.

It complies with the essential requirements of EEC Directives:

2014/35/EC Low Voltage Directive

2014/30/EC Electromagnetic Compatibility Directive

2014/53/EC Radio & Telecommunications Terminal Equipments Directive

The manufacturer declares that the start-up of the machinery is not permitted unless the machine, in which the product is incorporated or of which is becoming a component, has been identified and declared as conformed to 2006/42/EC Machinery Directive.

Note: These products have undergone test in a typical uniform configuration

Castagnito, January 19th 2018

Marco Gallo
Managing Director

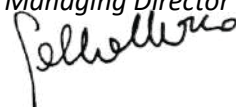

EUROMATIC

by **Proteco S.r.l.** Via Neive, 77 - 12050 Castagnito (CN) ITALY
Tel. +39 0173 210132 www.euromaticgate.net