

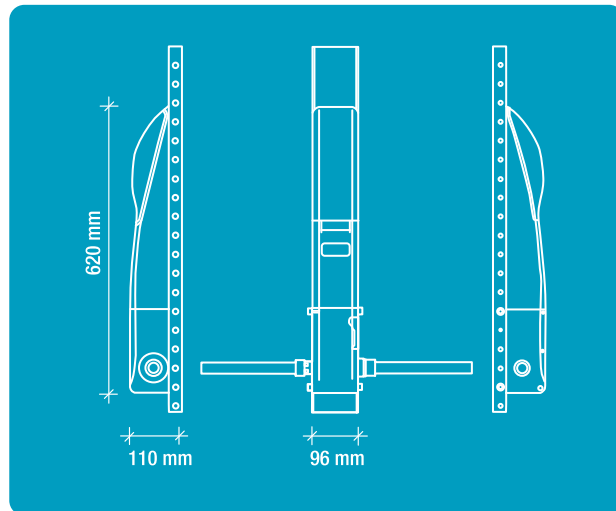

Swing

230V electromechanical opener for counterweighted and spring-balanced overhead garage doors up to 8 m².

- An irreversible gear motor with adjustable electromechanical limit switches, available with embedded control unit and built-in radio receiver, obstacle detection function, courtesy light and a handle for emergency manual release.
- The fixing bar (1.2 m) is included.



24V



8 m²

Swing

		SWING
Power supply	V	230V~50Hz
Current	A	1
Motor power	W	300
Class Protection	IP	54
Opening time	s	18"
Duty Cycle	%	50

Track-less 1-piece door

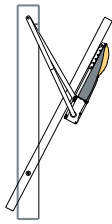
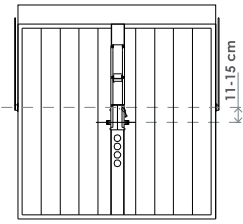

Track operated door

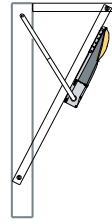
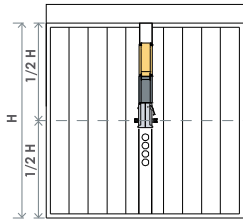

Folding door

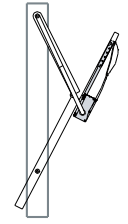
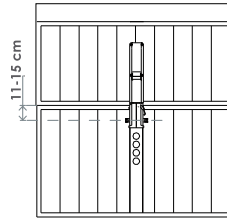

OPTIONAL ACCESSORIES



Photocells set
RF37



Emergency release kit
for external opening
B001



Safety edge
RC22



Brackets set for
central fixing
B002



Blinker light
EGGY



Brackets set for
side fixing
B003



Curved arms kit
for central
mounting
B004



Radio transmitters
JEDI



YEARS OF WARRANTY



RELIABLE



SAFE



EASY TO INSTALL
EASY TO BE
PROGRAMMED